

Refraction unit

OPHTHALMIC UNITS

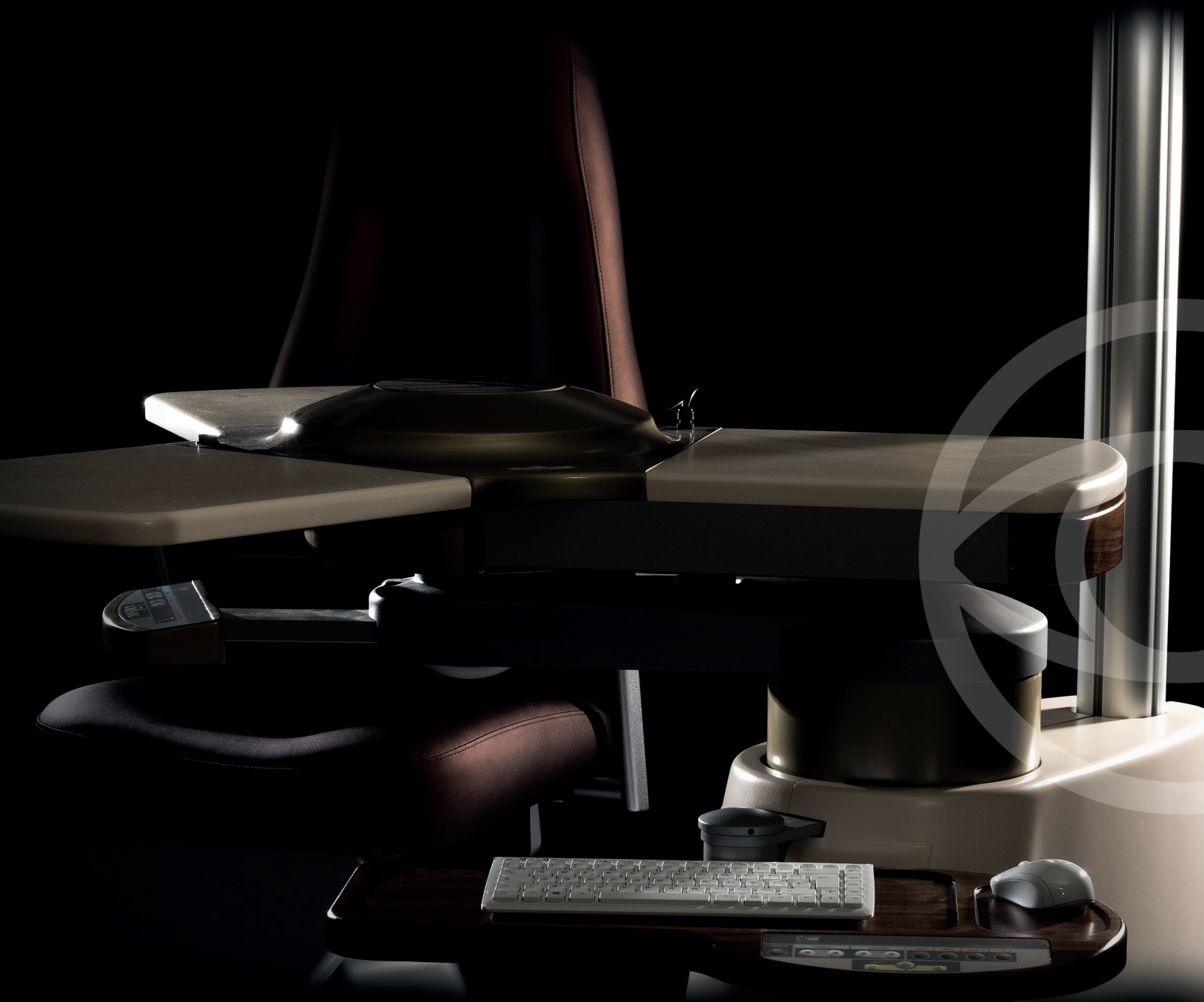



C.S.O. was established in 1967 as ophthalmological devices producer and soon becomes a world leader company for the production of a wide range of ophthalmological products.

The refraction units by C.S.O. are born at the beginning of the 90s to gather several ophthalmic devices in one solution characterized by harmonious lines, compact, ergonomic and long-lasting structure,

The C.S.O. refraction units are characterized by their practicality compatible with a wide range of devices for the modern ophthalmological diagnostic and they provide a pleasant daily working experience.

Thanks to an attentive selection of the materials used for the construction and a wide range of available colors and customizations, it is possible to realize a harmonious and comfortable working environment for the user and the patient.



Thank you for choosing C.S.O. as your supplier.





OPHTHALMIC UNIT

Vintage

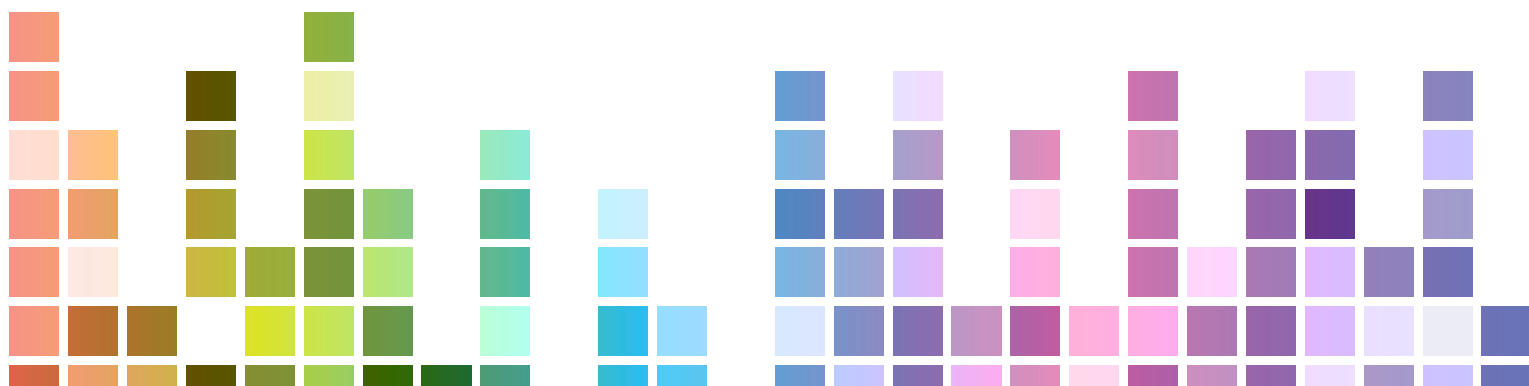

REFRACTION UNIT

VINTAGE it is a unit for 4 independent instruments which can be used also in resting position. It is customizable with any device and thanks to a control tab with microprocessor, allows the user to program the best working conditions for a fast and comfortable use.

The movements are manual and the unit is equipped with the powered elevation of the electrical plane. The unit is equipped also with a lenses tray and 2 storage drawers. As the whole range of CSO ophthalmic units, **VINTAGE** can be customized with a wide choice of colors.



Possibility to visit patients with motoric difficulties



Wooden finishing (optional)



Drawer for compartment of the accessories

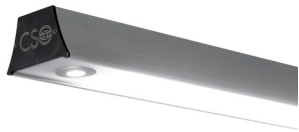

Ceiling light with three light sources suitable for every unit

with:

- LED light with adjustable intensity
- with light spot
- upper ambient LED light (optional)

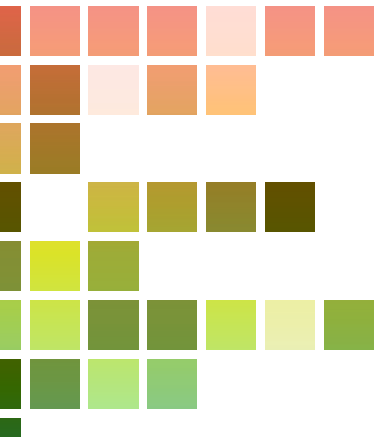

Lenses drawer



Commands console and drawers



Refraction units installed in the CSO mobile clinic



Compartment for 4 ophthalmic instruments

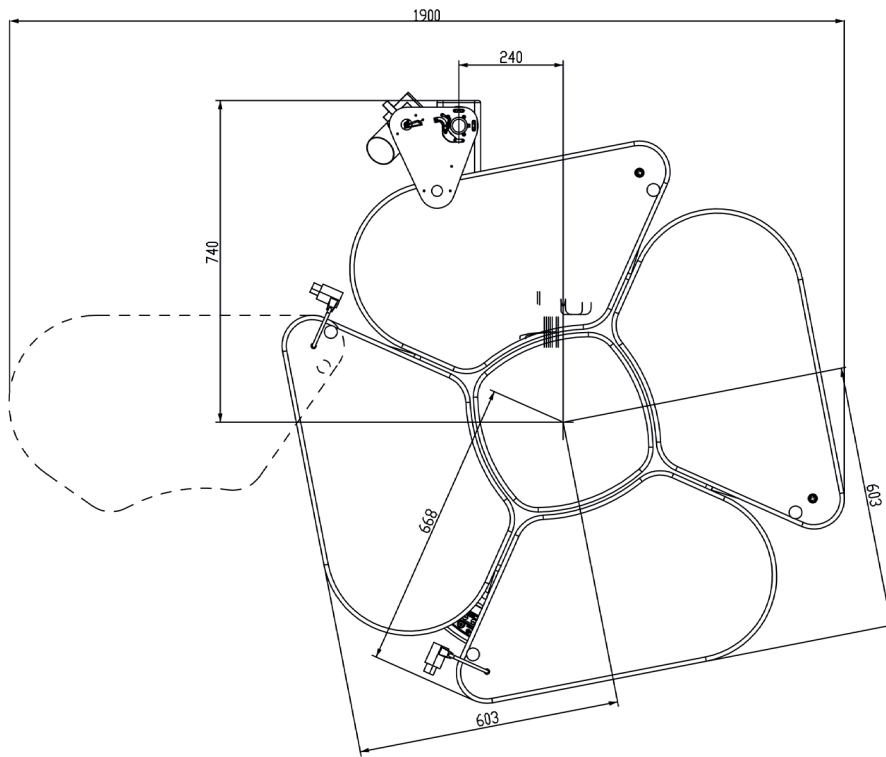

STANDARD EQUIPMENT

- Working plane with
- electronic height adjustment (min 80 cm max 96 cm)
- Two planes with low tension supply
- Two planes 230V supply
- Central structure with command panel
- Column with spot light with variable intensity
- Eye charts projector support
- Integrated lenses drawer
- 2 storage drawers

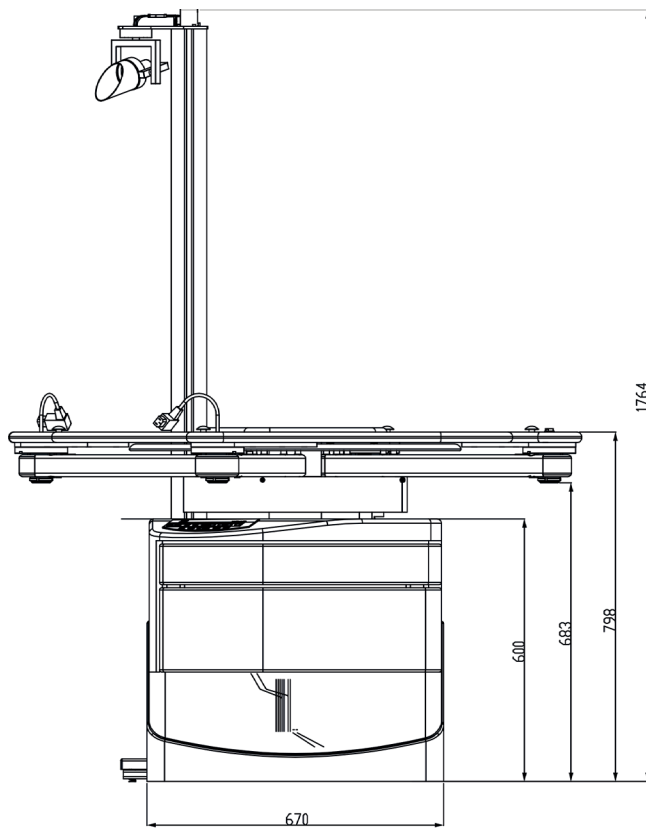

ACCESSORIES (OPTIONAL)

- Chair with electronic height adjustment
- Ceiling light with 3 LED lights with adjustable intensity
- Support for self-balancing arm for phoropter + support
- Arm with plane
- Wood's lamp with arm
- Arrangement video system
- LCD monitor support
- Arrangement for topographer
- Wheeled drawer and desk
- Drawer with commands in various configurations
- Hook for headband

ELECTRICAL DATA

	From	To
Supply voltage	90 V	264 V
Power frequency	47Hz	63Hz
Network fuses	4A T 5x20mm	8A T 5x20mm
Auxiliary sockets (chair and auxiliaries)	110Vac 50Hz	230Vac 60Hz
Max power absorbed by the auxiliary sockets	100 VA	100 VA
Max power absorbed by the unit:	600 VA	600 VA
Voltage for the table instruments	from 0 Vac to 24Vac Ophthalmometer Slit Lamp from 0Vac or 24Vac Fixation point of the Chin rest 2 x 220v for other diagnostic instrument	

Accessories



Phorofter arm
cod. 100805-02

Plate for projector (not CSO)
cod. 100805-05



Movable spotlight
cod. 100811550

Plane for column monitor
cod. 100805-03



Ophthalmic headband support
cod. 100805-21



CD monitor support
100805-24

Phorofter support for square section column
cod. 100805-10



Lamp with 3 LED lights
cod. 100819510



**Support for column
retinoscope/ophthalmometer**
cod. 10080518



COLORS*

They make the difference and give personality to the studio furniture.

COLORS LACQUERED - optional

		
cod. 107	cod. 132	cod. 135
		
cod. 156	cod. 162	cod. 223
		
cod. 218	cod. 208	cod. 187
		
cod. 757/296-D	cod. 182	cod. 131
		
cod. 118	cod. 120	cod. 130
		
cod. 228	cod. 236	cod. 849
		
cod. 945/C	cod. 244	cod. 259

LACQUED COLORS - standard

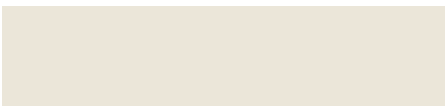
		
cod. 757/296-E	cod. 889/F	cod. 857/C

* The colors are just approximate.

Intensity color variations can be caused by the chemicals reactions of the used matters.

The specifications and the images are not contractually binding and can be modified without notice.



YOUR PROFESSIONAL PARTNER SINCE 1967



Via degli Stagnacci 12/E
50018 - Scandicci - FI - Italy
tel +39 055 72219 | fax +39 055 7215557
email. cso@csoitalia.it | web. www.csoitalia.it

